

Piktogramme/pictograms



Mineralmarmor Waschtisch
Marble minerals washbasin



LED Lichtfarbe kalt
LED colour temperature cold



LED mit Bewegungssensor
LED with motion sensor



Keramik Waschtisch
Ceramic washbasin



LED Lichtfarbe warm
LED colour temperature warm



LED mit Sensorschalter
LED with sensor switch



Glas Waschtisch
Glass washbasin



LED Lichtfarbe regelbar,
Helligkeit dimmbar
LED colour temperature adjust-
able, brightness dimmable



LED Lichtfarbe schaltbar bzw. regelbar
LED colour temperature adjustable

Keramik Waschtisch weiß alpin Glanz (KOK)

Ceramic washbasin gloss alpine white (KOK)

≈ Beckenmaße in cm (BxHxT)
basin dimensions in cm (WxHxD)

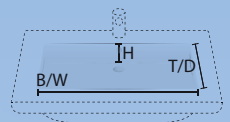

KWKOM65 | 54,5 x 11,5 x 39 cm



KWKOM85 | 65,5 x 11,5 x 38,5 cm



Detail



KWKOM95 | 65,5 x 11,5 x 38,5 cm

Befestigungsmaterial für Keramikwaschtisch MONK-4 MONK-4 fastening material for ceramic washbasin

Wir empfehlen eine Montage nur durch einen qualifizierten Monteur/Installateur. Keine Haftung bei unsachgemäßer Montage. Das Befestigungsmaterial für Standard-Keramikwaschtisch ist inklusive (2 Stockschrauben M10x120 inkl. Dübel für massive Steinwand. Bei anderen Wandbeschaffenheiten muss der Dübel entsprechend angepasst werden).

We recommend installation only by a qualified fitter / installer. No liability for improper installation. The mounting material for the standard ceramic washbasin is included (2 screws M10x120 including dowels for solid stone wall, for other wall conditions the dowel must be adapted accordingly).

Schränke/cabinets 3060

Frontfarben/front colours

Dickkante/thick edge

286



Weiß Seidenglanz
Silk Gloss White
KOE_

481



Teak Natur Nachbildung
Natural Teak Finish
KOT_

284



Anthrazit Seidenglanz
Silk Gloss Anthracite
KOA_

Korpusfarben/basic shell colours

PG 1

286



Weiß Seidenglanz
Silk Gloss White
E/KO86

481



Teak Natur Nachbildung
Natural Teak Finish
T/KO51

284



Anthrazit Seidenglanz
Silk Gloss Anthracite
A/KO84

Griffe/handles



Chrom Glanz
Gloss Chrome
281/282
⌀-⌀ 160 mm/416 mm

⌀-⌀ = Bohrabstand/hole spacing

Beleuchtung / lighting



Aufbauleuchte LED
Top light LED



Oberboden mit LED Strahlern
Top with LED spots

Lichtfarbe Tageslicht (Kalt)
Luminous colour natural light (cold)



AN60



Die Steckdose / Powerbox ist auch in Ausführung für die Schweiz / Frankreich erhältlich. Bitte Mehrpreis beachten (siehe Zubehör Seite 1).
The power socket is also available for Switzerland / France. Please note extra charge (see accessories page 1).

Konzept/concept 3060

Beleuchtung/lighting
LED Oberboden/LED top

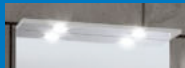

Beleuchtung/lighting
LED Aufbauleuchte/LED lighting



Waschtisch/washbasin

Waschtisch-
unterschrank/
washbasin base cabinet

Farben/
colours
Front + Korpus
front + carcass

Breite 60 cm / width 60 cm



1 Tür/1 door
SOBC6

Spiegelschrank/mirror cabinet



1 Tür/1 door
SANB6

Spiegelschrank/mirror cabinet



2 Türen/2 doors
SOBC6R
SOBC6L

Spiegelschrank/mirror cabinet



2 Türen/2 doors
SANB6R
SANB6L

Spiegelschrank/mirror cabinet



SPOBC6

Spiegelpaneel/mirror panel



SPANB6

Spiegelpaneel/mirror panel



Keramik Waschtisch/
ceramic washbasin
KWKOM65



Unterschrank 2 Auszüge/
base cabinet 2 extensions
WKKAA6

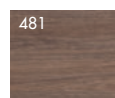

Breite 80 cm / width 80 cm



3 Türen/3 doors
SOBC8

Spiegelschrank/mirror cabinet



3 Türen/3 doors
SANB8

Spiegelschrank/mirror cabinet



SPOBC8

Spiegelpaneel/mirror panel



SPANB8

Spiegelpaneel/mirror panel



Keramik Waschtisch/
ceramic washbasin
KWKOM85



Unterschrank 2 Auszüge/
base cabinet 2 extensions
WKKAA8

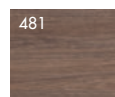
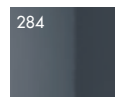
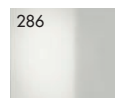

Breite 90 cm / width 90 cm



3 Türen/3 doors
SOBC9

Spiegelschrank/mirror cabinet



3 Türen/3 doors
SANB9

Spiegelschrank/mirror cabinet



SPOBC9

Spiegelpaneel/mirror panel



SPANB9

Spiegelpaneel/mirror panel









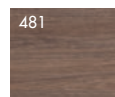
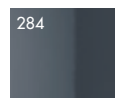

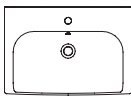

Keramik Waschtisch/
ceramic washbasin
KWKOM95

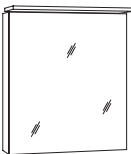

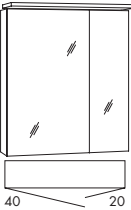
Unterschrank 2 Auszüge/
base cabinet 2 extensions
WKKAA9

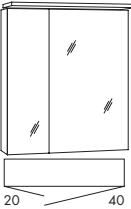

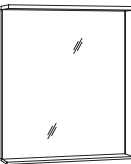







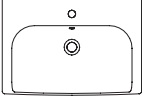

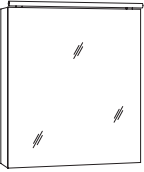
3060 »60 cm beleuchteter Oberboden/top with LED spotlights«

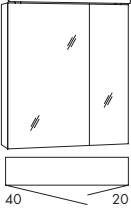

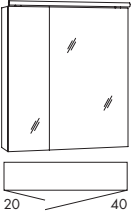

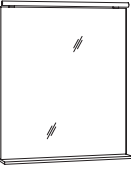



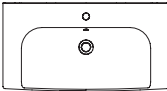

Beschreibung Description	Maße in cm Dimensions in cm			Artikel-Nr. Article no.	Türanschlag Door stop	Identnummer ID number
	B/W	H	T/D			
 <p>Keramik-Waschtisch inkl. Überlauf</p> <p><i>ceramic washbasin incl. overflow</i></p>	65	6	45	KWKOM65		
						
						PG1 Dickkante/thick edge
 <p>Waschtisch-Unterschrank 2 Auszüge</p> <p><i>washbasin base cabinet 2 extensions</i></p>	60	49,5	41,6	WKKAA6		
 <p>Spiegelschrank, 1 Spiegeltür, 2 Glaseinlegeböden, Oberboden mit 2x2,0 W LED-Strahler 6000 Kelvin, inkl. Schalter/Steckdose EEK A-A++</p> <p><i>mirror cabinet, 1 mirror door, 2 glass shelves, top with 2x2,0 W LED spotlights 6000 Kelvin incl. switch/socket EEC A-A++</i></p>	60	70,8	17,6	SOBC6	L/R	
						
 <p>Spiegelschrank, 2 Spiegeltüren (Innenspiegel), 2 Glaseinlegeböden, Oberboden mit 2x2,0 W LED-Strahler 6000 Kelvin, inkl. Schalter/Steckdose EEK A-A++</p> <p><i>mirror cabinet, 2 mirror doors (inside mirror), 2 glass shelves, top with 2x2,0 W LED spotlights 6000 Kelvin incl. switch/socket EEC A-A++</i></p>	60	70,8	17,6	SOBC6L		
						
 <p>Spiegelschrank, 2 Spiegeltüren (Innenspiegel), 2 Glaseinlegeböden, Oberboden mit 2x2,0 W LED-Strahler 6000 Kelvin inkl. Schalter/Steckdose EEK A-A++</p> <p><i>mirror cabinet, 2 mirror doors (inside mirror), 2 glass shelves, top with 2x2,0 W LED spotlights 6000 Kelvin incl. switch/socket EEC A-A++</i></p>	60	70,8	17,6	SOBC6R		
						
 <p>Spiegelpaneel mit Glasablage 60x1x12 cm Oberboden mit 2x2,0 W LED-Strahler 6000 Kelvin, inkl. Schalter Mitte rechts EEK A-A++</p> <p><i>mirror panel with glas board 60x1x12 cm top with 2x2,0 W LED spotlights 6000 Kelvin, incl. switch center right EEC A-A++</i></p>	60	70,8	3/ 12	SPOBC6		
						

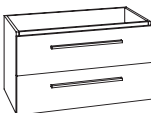
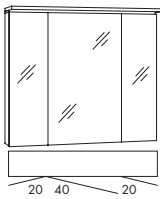
EEK/EEC=Energieeffizienzklasse/energy efficiency category

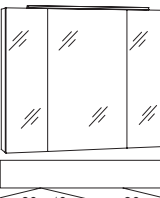

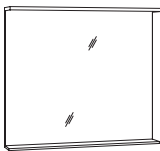

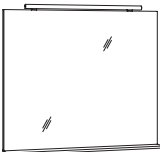



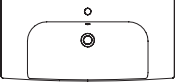

3060 »60 cm LED-Aufsatzleuchte/LED-lighting«

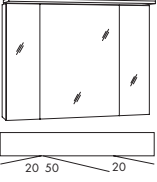
Beschreibung Description	Maße in cm Dimensions in cm			Artikel-Nr. Article no.	Türanschlag Door stop	Identnummer ID number
	B/W	H	T/D			
 <p>Keramik-Waschtisch inkl. Überlauf</p> <p><i>ceramic washbasin incl. overflow</i></p>	65	6	45	KWKOM65		
						
						PG1 Dickkante/thick edge
 <p>Waschtisch-Unterschrank 2 Auszüge</p> <p><i>washbasin base cabinet 2 extensions</i></p>	60	49,5	41,6	WKKAA6		
 <p>Spiegelschrank, 1 Spiegeltür, 2 Glaseinlegeböden, LED Aufbauleuchte AN60 3,7 W 6000 Kelvin inkl. Schalter/Steckdose EEK A-A++</p> <p><i>mirror cabinet, 1 mirror door, 2 glass shelves, LED lighting AN60 3,7 W 6000 Kelvin incl. switch/socket EEC A-A++</i></p>	60	68,2	17,6	SANB6	L/R	
						
 <p>Spiegelschrank, 2 Spiegeltüren (Innenspiegel), 2 Glaseinlegeböden, LED Aufbauleuchte AN60 3,7 W 6000 Kelvin inkl. Schalter/Steckdose EEK A-A++</p> <p><i>mirror cabinet, 2 mirror doors (inside mirror), 2 glass shelves, LED lighting AN60 3,7 W 6000 Kelvin incl. switch/socket EEC A-A++</i></p>	60	68,2	17,6	SANB6L		
						
 <p>Spiegelschrank, 2 Spiegeltüren (Innenspiegel), 2 Glaseinlegeböden, LED Aufbauleuchte AN60 3,7 W 6000 Kelvin inkl. Schalter/Steckdose EEK A-A++</p> <p><i>mirror cabinet, 2 mirror doors (inside mirror), 2 glass shelves, LED lighting AN60 3,7 W 6000 Kelvin incl. switch/socket EEC A-A++</i></p>	60	68,2	17,6	SANB6R		
						
 <p>Spiegelpaneel mit Glasablage 60x1x12 cm LED Aufbauleuchte AN60 3,7 W 6000 Kelvin, inkl. Schalter Mitte rechts EEK A-A++</p> <p><i>mirror panel with glas board 60x1x12 cm LED lighting AN60 3,7 W 6000 Kelvin incl. switch center right EEC A-A++</i></p>	60	69,2	3	SPANB6		
						

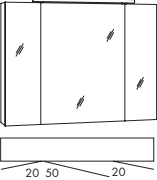
EEK/EEC=Energieeffizienzklasse/energy efficiency category

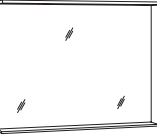

Beschreibung Description	Maße in cm Dimensions in cm			Artikel-Nr. Article no.	Türanschlag Door stop	Identnummer ID number
	B/W	H	T/D			
 <p>Keramik-Waschtisch inkl. Überlauf</p> <p>ceramic washbasin incl. overflow</p>	85	6	45	KWKOM85		
						PG1 Dickkante/thick edge
 <p>Waschtisch-Unterschrank 2 Auszüge</p> <p>washbasin base cabinet 2 extensions</p>	80	49,5	41,6	WKKAA8		
 <p>Spiegelschrank, 3 Spiegeltüren, 6 Glaseinlegeböden, Oberboden mit 2x2,0 W LED-Strahler 6000 Kelvin inkl. Schalter/Steckdose EEK A-A++</p> <p>mirror cabinet, 3 mirror doors, 6 glass shelves, top with 2x2,0 W LED spotlights 6000 Kelvin incl. switch/socket EEC A-A++</p>	80	70,8	17,6	SOBC8		
 <p>Spiegelschrank, 3 Spiegeltüren, 6 Glaseinlegeböden, LED Aufbauleuchte AN60 3,7 W 6000 Kelvin inkl. Schalter/Steckdose EEK A-A++</p> <p>mirror cabinet, 3 mirror doors, 6 glass shelves, LED lighting AN60 3,7 W 6000 Kelvin incl. switch/socket EEC A-A++</p>	80	68,2	17,6	SANB8		
 <p>Spiegelpaneel mit Glasablage 80x1x12 cm Oberboden mit 2x2,0 W LED-Strahler 6000 Kelvin, inkl. Schalter Mitte rechts EEK A-A++</p> <p>mirror panel with glas board 80x1x12 cm top with 2x2,0 W LED spotlights 6000 Kelvin, incl. switch center right EEK A-A++</p>	80	70,8	3/ 12	SPOBC8		
 <p>Spiegelpaneel mit Glasablage 80x1x12 cm LED Aufbauleuchte AN60 3,7 W 6000 Kelvin, inkl. Schalter Mitte rechts EEK A-A++</p> <p>mirror panel with glas board 80x1x12 cm LED lighting AN60 3,7 W 6000 Kelvin incl. switch center right EEK A-A++</p>	80	69,2	3	SPANB8		









EEK/EEC=Energieeffizienzklasse/energy efficiency category

Beschreibung Description	Maße in cm Dimensions in cm			Artikel-Nr. Article no.	Türanschlag Door stop	Identnummer ID number
	B/W	H	T/D			
 <p>Keramik-Waschtisch inkl. Überlauf</p> <p><i>ceramic washbasin incl. overflow</i></p>	95	6	45	KWKOM95		
PG1 Dickkante/thick edge						
 <p>Waschtisch-Unterschrank 2 Auszüge</p> <p><i>washbasin base cabinet 2 extensions</i></p>	90	49,5	41,6	WKKAA9		
 <p>Spiegelschrank, 3 Spiegeltüren, 6 Glaseinlegeböden, Oberboden mit 3x2,0 W LED-Strahler 6000 Kelvin inkl. Schalter/Steckdose EEK A-A++</p> <p><i>mirror cabinet, 3 mirror doors, 6 glass shelves, top with 3x2,0 W LED spotlights 6000 Kelvin incl. switch/socket EEC A-A++</i></p>	90	70,8	17,6	SOBC9		
 <p>Spiegelschrank, 3 Spiegeltüren, 6 Glaseinlegeböden, LED Aufbauleuchte AN60 3,7 W 6000 Kelvin inkl. Schalter/Steckdose EEK A-A++</p> <p><i>mirror cabinet, 3 mirror doors, 6 glass shelves, LED lighting AN60 3,7 W 6000 Kelvin incl. switch/socket EEC A-A++</i></p>	90	68,2	17,6	SANB9		
 <p>Spiegelpaneel mit Glasablage 90x1x12 cm Oberboden mit 3x2,0 W LED-Strahler 6000 Kelvin, inkl. Schalter Mitte rechts EEK A-A++</p> <p><i>mirror panel with glas board 90x1x12 cm top with 3x2,0 W LED spotlights 6000 Kelvin, incl. switch center right EEK A-A++</i></p>	90	70,8	3/ 12	SPOBC9		
 <p>Spiegelpaneel mit Glasablage 90x1x12 cm LED Aufbauleuchte AN60 3,7 W 6000 Kelvin, inkl. Schalter Mitte rechts EEK A-A++</p> <p><i>mirror panel with glas board 90x1x12 cm LED lighting AN60 3,7 W 6000 Kelvin incl. switch center right EEK A-A++</i></p>	90	69,2	3	SPANB9		



EEK/EEC=Energieeffizienzklasse/energy efficiency category

3060 »Beistellschränke/side cabinets«

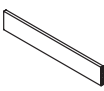
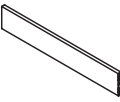
Beschreibung Description	Maße in cm Dimensions in cm			Artikel-Nr. Article no.	Türanschlag Door stop	Identnummer ID number
	B/W	H	T/D			
 <p>Highboard inkl. Abdeckplatte 1 Tür, 1 Schubkasten 2 Glaseinlegeböden</p> <p><i>high cabinet incl. top 1 door, 1 drawer 2 glass shelves</i></p>	40	91	34,8	HBST4FL HBST4FR	Links/ <i>left</i> Rechts/ <i>right</i>	PG1 Dickkante/ <i>thick edge</i>
 <p>Mittelschrank inkl. Abdeckplatte 2 Türen, 1 Schubkasten 3 Glaseinlegeböden</p> <p><i>medium cabinet incl. top 2 doors, 1 drawer 3 glass shelves</i></p>	40	148,6	34,8	MTST4FL MTST4FR	Links/ <i>left</i> Rechts/ <i>right</i>	
 <p>Hochschrank 2 Türen, 1 Schubkasten 3 Glaseinlegeböden</p> <p><i>tower cabinet 2 doors / 1 drawer 3 glass shelves</i></p>	40	178,8	34,8	HTST4L HTST4R	Links/ <i>left</i> Rechts/ <i>right</i>	

Beschreibung Description	Maße in cm Dimensions in cm			Artikel-Nr. Article no.	Türanschlag Door stop	Identnummer ID number
	B/W	H	T/D			
 <p>Handtuchhalter 1-armig (Befestigung am Schrank)</p> <p><i>towel rail 1-arm (fastening on the cabinet)</i></p>	5	1	33	HHF133		
 <p>Handtuchhalter 1-armig (Befestigung am Schrank) ausziehbar</p> <p><i>towel rail 1-arm (fastening on the cabinet) pull out</i></p>	7,5	4	32,5/ 50	HH133		
 <p>Handtuchhalter 2-armig (Befestigung am Schrank) ausziehbar</p> <p><i>towel rail 2-arms (fastening on the cabinet) pull out</i></p>	10,5	4	32,5/ 50	HH233		
 <p>Handtuchhalter verchromt (Befestigung am Schrank)</p> <p><i>chromed towel rail (fastening on the cabinet)</i></p>	5	2,5	40	RHH		
 <p>Spiegelschrank-Unterbauleuchtung 5,8 W LED EEK A–A++ (für Spiegelschrank ab 60 cm Breite), 6000 Kelvin Beleuchtung kann unter Spiegel- schränken und unter Regalen verbaut werden.</p> <p><i>base lighting for mirror cabinet 5,8 W LED EEC A–A++ (for mirror cabinet ex 60 cm width), 6000 Kelvin Lighting can be installed under mirror cabinets and under shelves.</i></p>	57			WTBP60		
 <p>Spiegelschrank-Unterbauleuchtung 3,4 W LED EEK A–A++ (für Spiegel- schrank ab 80 cm Breite) 6000 Kelvin Beleuchtung kann nur unter Spiegel- schränke und nicht unter Regale verbaut werden.</p> <p><i>base lighting for mirror cabinet 3,4 W LED EEC A–A++ (for mirror cabinet ex 80 cm width) 6000 Kelvin Lighting only can be installed under mirror cabinets and not under shelves.</i></p>	70			WTB70		
 <p>Inneneinteilung für 60 cm Auszug</p> <p><i>internal subdivison for 60 cm extension</i></p>	58	6	1,1	IEG60		
 <p>Inneneinteilung für 80 cm Auszug</p> <p><i>internal subdivison for 80 cm extension</i></p>	78	6	1,1	IEG80		
 <p>Inneneinteilung für 90 cm Auszug</p> <p><i>internal subdivison for 90 cm extension</i></p>	88	6	1,1	IEG90		

EEK/EEC=Energieeffizienzklasse/energy efficiency category

Beschreibung Description	Maße in cm Dimensions in cm			Artikel-Nr. Article no.	Türanschlag Door stop	Identnummer ID number
	B/W	H	T/D			
 <p>Schubkasteneinsatz (Kunststoff) für Schubkasten B: 40 cm / T: 30 cm für Beistellschränke</p> <p>drawer insert part (plastic) for drawer 40 cm w: 40cm / d: 30 cm for side cabinets</p>	30,9	4,5	28	SEG4		
 <p>Schubkasteneinsatz (Kunststoff) für oberen Auszug vom WT-Unterschrank</p> <p>drawer insert part (plastic) for top drawer from base cabinet</p>	33,7	4,3	33	SMBEG3		

KWKOM65

[KWKOM6 + MONK-4]

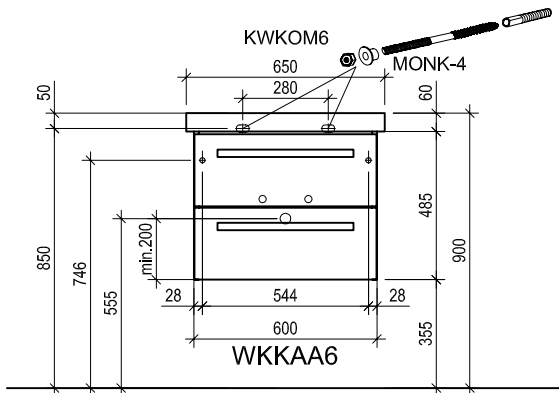

KWKOM95

[KWKOM9 + MONK-4]

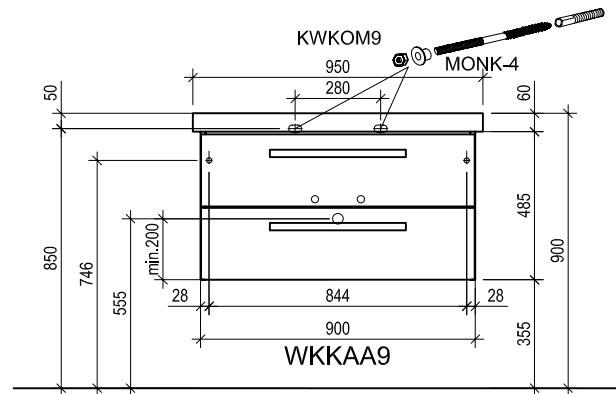

KWKOM85

[KWKOM8 + MONK-4]

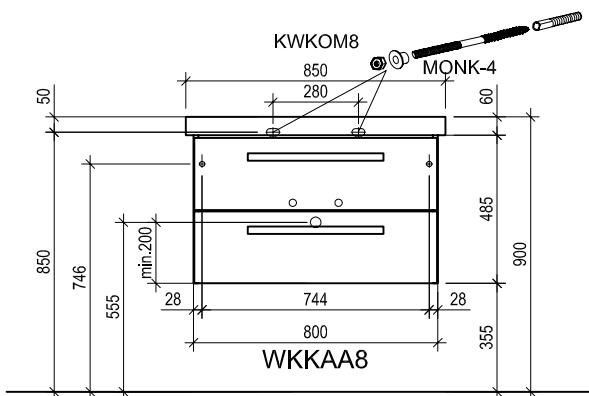

! Achtung: Die Montage muss durch fachkundige Personen erfolgen. Der Untergrund zur Wandbefestigung ist vor Montage zu prüfen. Bitte wählen Sie entsprechend das geeignete Befestigungsmaterial. Fehlerhafte Montagen können das Möbel beschädigen oder dessen Funktion dauerhaft beeinträchtigen. Für Sach- und Personenschäden übernehmen wir im Falle einer unsachgemäßen Montage keine Haftung.
 Attention: Assembly must be carried out by skilled personnel. The subsurface for the wall mounting must be checked before assembly. Please select a suitable mounting material. Faulty assembly can damage furniture or permanently impair its function. We will not be held responsible for damage to material or persons in the case of improper assembly.

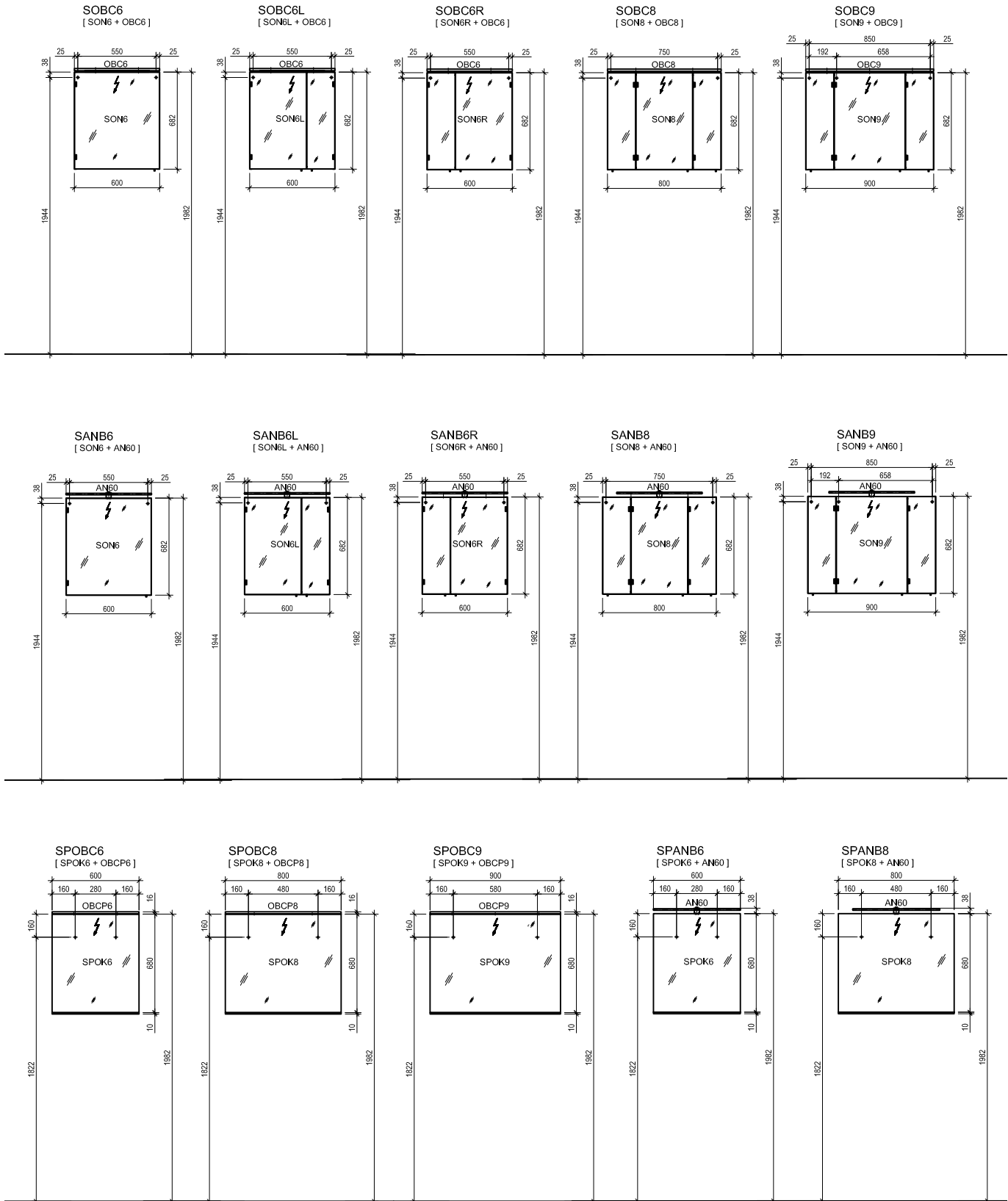

Achtung: Die Montage muss durch fachkundige Personen erfolgen. Der Untergrund zur Wandbefestigung ist vor Montage zu prüfen. Bitte wählen Sie entsprechend das geeignete Befestigungsmaterial. Fehlerhafte Montagen können das Möbel beschädigen oder dessen Funktion dauerhaft beeinträchtigen. Für Sach- und Personenschäden übernehmen wir im Falle einer unsachgemäßen Montage keine Haftung.

Attention: Assembly must be carried out by skilled personnel. The subsurface for the wall mounting must be checked before assembly. Please select a suitable mounting material. Faulty assembly can damage furniture or permanently impair its function. We will not be held responsible for damage to material or persons in the case of improper assembly.

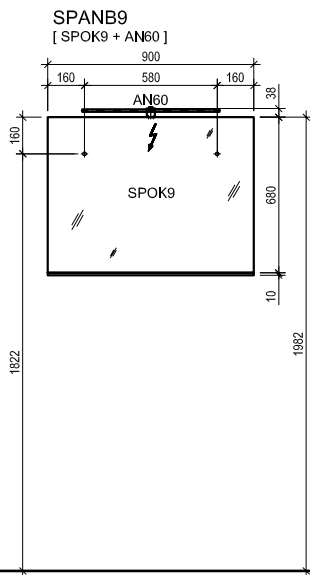

HBST4F

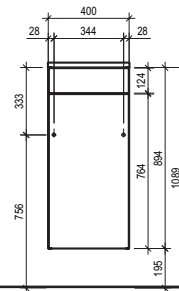

MTST4F

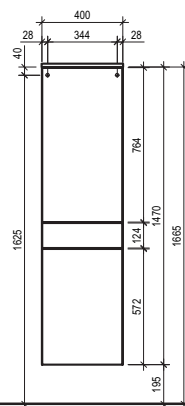

HTST4

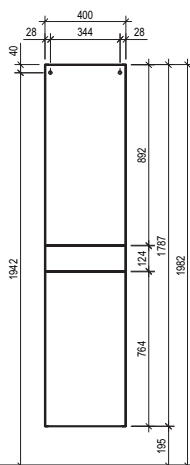

! Achtung: Die Montage muss durch fachkundige Personen erfolgen. Der Untergrund zur Wandbefestigung ist vor Montage zu prüfen. Bitte wählen Sie entsprechend das geeignete Befestigungsmaterial. Fehlerhafte Montagen können das Möbel beschädigen oder dessen Funktion dauerhaft beeinträchtigen. Für Sach- und Personenschäden übernehmen wir im Falle einer unsachgemäßen Montage keine Haftung.
Attention: Assembly must be carried out by skilled personnel. The subsurface for the wall mounting must be checked before assembly. Please select a suitable mounting material. Faulty assembly can damage furniture or permanently impair its function. We will not be held responsible for damage to material or persons in the case of improper assembly.



Haben Sie Fragen oder Anregungen?
Kontaktieren Sie uns gerne!

Wir sind telefonisch für Sie da:

Montag bis Freitag: 09:30 bis 18:00 Uhr



03606 / 50 77 70

Oder jederzeit per E-Mail unter:



info@badshop.de

Gern können Sie auch jederzeit
[online](#) einen Beratungstermin
in unserer Ausstellung vereinbaren.